

Bonfiglioli **Riduttori**

BX Heavy Duty series

Installation, Operation
and Maintenance Manual

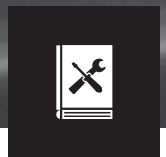

USER
MANUAL

 **Bonfiglioli**
Forever Forward



Contents

Contents	3
1 Introduction	5
1.1 Declaration of Conformity	5
1.2 Validity	5
2 Safety considerations	6
3 Handling	7
3.1 Reception	7
3.2 Transportation and storage	7
3.3 Lifting	8
3.4 Motor weight	8
4 Installation and commissioning	9
4.1 General	9
4.2 Motors with other than deep groove ball bearings	9
4.3 Insulation resistance check	10
4.4 Foundation	10
4.5 Balancing and fitting coupling halves and pulleys	11
4.6 Mounting and alignment of the motor	11
4.7 Radial forces and belt drives	11
4.8 Motors with drain plugs for condensation	12
4.9 Cabling and electrical connections	12
4.9.1 Connections for different starting methods	13
4.9.2 Connections of auxiliaries	13
4.10 Terminals and direction of rotation	13
5 Operation	14
5.1 General	14
6 Low voltage motors in variable speed operation	15
6.1 Introduction	15
6.2 Winding insulation	15
6.3 Thermal protection	15
6.2.1 Selection of winding insulation with converters	15
6.4 Bearing currents	16
6.4.1 Elimination of bearing currents with converters	16
6.5 Cabling, grounding and EMC	16
6.6 Operating speed	17
6.7 Motors in variable speed applications	17
6.7.1 General	17
6.7.2 Motor loadability with voltage source PWM-type converters	
6.7.3 Short time overloads	18
6.8 Rating plates	18
6.9 Commissioning the variable speed application	18
7 Maintenance	19
7.1 General inspection	19
7.1.1 Standby motors	19
7.2 Lubrication	20

- 7.2.1 Motors with permanently greased bearings 20
- 7.2.2 Motors with regreasable bearings 20
- 7.2.3 Lubrication intervals and amounts 21
- 7.2.4 Lubricants 22
- 8 After Sales Support 23**
 - 8.1 Spare parts. 23**
 - 8.2 Dismantling, re-assembly and rewinding. 23**
 - 8.3 Bearings 23**
- 9 Environmental requirements 24**
 - 9.1 EU Directive 2012/19/EU (WEEE) 24**
 - 9.1.1 Marking of the products. 24
 - 9.1.2 For private households 24
 - 9.1.3 For professional users in the European Union. 24
 - 9.1.4 For disposal in countries outside of the European Union. 25
- 10 Troubleshooting 26**
- 11 Figures 28**



1 Introduction



These instructions must be followed to ensure safe and proper installation, operation and maintenance of the motor. They should be brought to the attention of anyone who installs, operates or maintains the motor or associated equipment. The motor is intended for installation and use by qualified personnel, familiar with health and safety requirements and national legislation. Ignoring these instructions may invalidate all applicable warranties.

1.1 Declaration of Conformity

The conformity of the end product according to Directive 2006/42/EC (Machinery) has to be established by the commissioning party when the motor is fitted to the machinery.

1.2 Validity

These instructions are valid for the following Bonfiglioli electrical machine types, in both motor and generator operation:

series BX...,
series BX...K
in frame sizes 200-355.

There is a separate manual for e.g. Ex motors 'Low voltage motors for explosive atmospheres: Installation, operation and maintenance and safety manual (3GZF500730-47)
Additional information is required for some machine types due to special application

and/or design considerations.

Additional manual is available for the following motors:

- roller table motors
- water cooled motors
- smoke extraction motors
- brake motors
- motors for high ambient temperatures
- motors in marine applications for mounting on open deck
- of ships or offshore units

2 Safety considerations

The motor is intended for installation and use by qualified personnel, familiar with health and safety requirements and national legislation.

Safety equipment necessary for the prevention of accidents at the installation and operating site must be provided in accordance with local regulations.



WARNING

Emergency stop controls must be equipped with restart lockouts. After emergency stop a new start command can take effect only after the restart lockout has been intentionally reset.

Points to be observed:

1. Do not step on the motor.
2. The temperature of the outer casing of the motor may be hot to the touch during normal operation and especially after shut-down.
3. Some special motor applications may require additional instructions (e.g. when supplied by frequency converter).
4. Observe rotating parts of the motor.
5. Do not open terminal boxes while energized.

3 Handling

3.1 Reception

Immediately upon receipt, check the motor for external damage (e.g. shaft-ends, flanges and painted surfaces) and, if found, inform the forwarding agent without delay.

Check all rating plate data, especially voltage and winding connections (star or delta). The type of

bearing is specified on the rating plate of all motors except the smallest frame sizes.

In the case of a variable speed drive application check the maximum loadability allowed according to frequency stamped on the motor's second rating plate.

3.2 Transportation and storage

The motor should always be stored indoors (above $-20\text{ }^{\circ}\text{C}$), in dry, vibration-free and dust-free conditions. During transportation, shocks, falls and humidity should be avoided. In other conditions, please contact Bonfiglioli.

Unprotected machined surfaces (shaft-ends and flanges) should be treated against corrosion.

It is recommended that shafts are rotated periodically (once per quarter) by hand to prevent grease migration.

Anti-condensation heaters, if fitted, are recommended to be used to avoid water condensing in the motor.

The motor must not be subject to any external vibrations at standstill so as to avoid causing damage to the bearings.

Motors fitted with cylindrical-roller and/or angular contact bearings must be fitted with locking devices during transport.

3.3 Lifting

All Bonfiglioli motors above 25 kg are equipped with lifting lugs or eyebolts.

Only the main lifting lugs or eyebolts of the motor should be used for lifting the motor. They must not be used to lift the motor when it is attached to other equipment.

Lifting lugs for auxiliaries (e.g. brakes, separate cooling fans) or terminal boxes must not be used for lifting the motor. Because of different output, mounting arrangements and auxiliary equipment, motors with the same frame may have a different center of gravity.

Damaged lifting lugs must not be used. Check that eyebolts or integrated lifting lugs are undamaged before lifting.

Lifting eyebolts must be tightened before lifting. If needed, the position of the eyebolt can be adjusted using suitable washers as spacers.

Ensure that proper lifting equipment is used and that the sizes of the hooks are suitable for the lifting lugs.

Care must be taken not to damage auxiliary equipment and cables connected to the motor.

Remove eventual transport jigs fixing the motor to the pallet.

Specific lifting instructions are available from Bonfiglioli.

3.4 Motor weight

The total motor weight can vary within the same frame size (center height) depending on different output, mounting arrangement and auxiliaries.

The following table shows estimated maximum weights for machines in their basic versions as a function of frame material.

The actual weight of all Bonfiglioli's motors is shown on the rating plate.

—
Table 3.1: Minimum cross-sectional area of protective conductors

Frame size	Aluminum, Weight kg	Cast iron, Weight kg	Add. for brake
56	4.5	–	–
63	6	–	–
71	8	13	5
80	14	20	8
90	20	30	10
100	32	40	16
112	36	50	20
132	93	90	30
160	149	130	30
180	162	190	45
200	245	275	55
225	300	360	75
250	386	405	75
280	425	800	–
315	–	1700	–
355	–	2700	–
400	–	3500	–
450	–	4500	–

If the motor is equipped with a separate fan, contact Bonfiglioli for the weight.

4 Installation and commissioning



WARNING

Disconnect and lock out before working on the motor or the driven equipment.

4.1 General

All rating plate values must be carefully checked to ensure that the motor protection and connection will be properly done.

When starting the motor for the first time or after it has been in storage more than 6 months, apply the specified quantity of grease.

See section “7.2.2 Motors with re-greasable bearings” for more details.

When fitted in a vertical position with the shaft pointing downwards, the motor must have a protective cover to prevent foreign objects and fluid from falling into the ventilation openings. This task can also be achieved by a separate cover not fixed to the motor. In this case, the motor must have a warning label.

4.2 Motors with other than deep groove ball bearings

Remove transport locking if employed. Turn the shaft of the motor by hand to check free rotation, if possible.

Motors equipped with cylindrical roller bearings:

Running the motor with no radial force applied to the shaft may damage the roller bearing due to “sliding”,

Motors equipped with angular contact ball bearing:

Running the motor with no axial force applied in the right direction in relation to the shaft may damage the angular contact bearing.



WARNING

For motors with angular contact bearings the axial force must not by any means change direction.

The type of bearing is specified on the rating plate.

4.3 Insulation resistance check

Measure insulation resistance (IR) before commissioning, after long periods of standstill or storage when winding dampness may be suspected. IR shall be measured directly on the motor terminals with the supply cables disconnected in order to avoid them affecting the result.

Insulation resistance should be used as a trend indicator to determine changes in the insulation system. In new machines the IR is usually thousands of Mohms and thus following the change of IR is important so as to know the condition of the insulation system. Typically, the IR should not be below 10 MΩ and in no case below 1 MΩ (measured with 500 or 1000 VDC and corrected to 25 °C). The insulation resistance value is halved for each 20 °C increase in temperature.

Figure 1, in chapter 11, can be used for the insulation correction to the desired temperature.



WARNING

To avoid risk of electrical shock, the motor frame must be grounded and the windings should be discharged against the frame immediately after each measurement.

If the reference resistance value is not attained, the winding is too damp and must be oven dried. The oven temperature should be 90 °C for 12-16 hours followed by 105 °C for 6-8 hours.

If fitted drain hole plugs must be removed and closing valves must be opened during heating. After heating, make sure the plugs are refitted. Even if the drain plugs are fitted, it is recommended to disassemble the end shields and terminal box covers for the drying process.

Windings drenched in seawater normally need to be rewound.

4.4 Foundation

The end user has full responsibility for preparation of the foundation.

Metal foundations should be painted to avoid corrosion.

Foundations must be even and sufficiently rigid to withstand possible short circuit forces. They must be designed and dimensioned to avoid the transfer of vibration to the motor and vibration caused by resonance. See figure below.

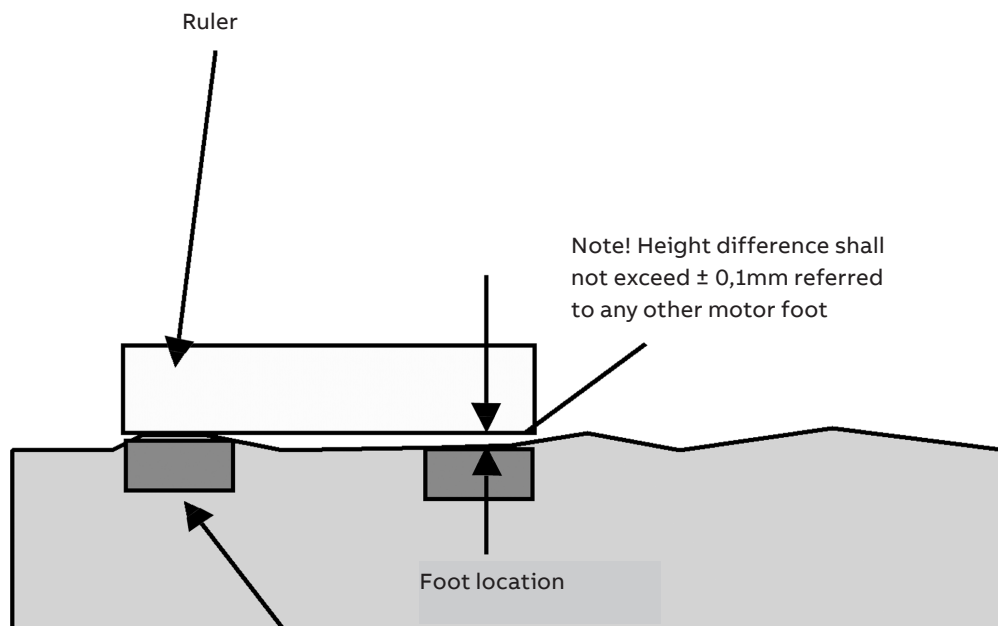

4.5 Balancing and fitting coupling halves and pulleys

As standard, balancing of the motor has been carried out using half key.

Coupling halves or pulleys must be balanced after machining the keyways. Balancing must be done in accordance with the balancing method specified for the motor.

Coupling halves and pulleys must be fitted on the shaft by using suitable equipment and tools which do not damage the bearings and seals.

Never fit a coupling half or pulley by hammering or removing it by using a lever pressed against the body of the motor.

4.6 Mounting and alignment of the motor

Ensure that there is enough space for free airflow around the motor. It is recommended to have a clearance between the fan cover and the wall etc. of at least $\frac{1}{2}$ of the air intake of the fan cover. Additional information may be found from the product catalog.

Correct alignment is essential to avoid bearing, vibration and possible shaft failures.

Mount the motor on the foundation using the appropriate bolts or studs and place shim plates between the foundation and the feet.

Align the motor using appropriate methods.

If applicable, drill locating holes and fix the locating pins into position.

Mounting accuracy of coupling half: check that

clearance b is less than 0.05 mm and that the difference a_1 to a_2 is also less than 0.05 mm. See figure 2.

Re-check the alignment after final tightening of the bolts or studs.

Do not exceed permissible loading values for bearings as stated in the product catalogs.

Check that the motor has sufficient airflow. Ensure that no nearby objects or direct sunshine radiate additional heat to the motor.

For flange mounted motors (e.g. B5, B35, V1), make sure that the construction allows sufficient air flow on the outer surface of the flange.

4.7 Radial forces and belt drives

Belts must be tightened according to the instructions of the supplier of the driven equipment. However, do not exceed the maximum belt forces (i.e. radial bearing loading) stated in the relevant product catalogs.



WARNING

Excessive belt tension will damage bearings and can cause shaft damage.

4.8 Motors with drain plugs for condensation

Check that drain holes and plugs face downwards. In vertical position mounted motors, the drain plugs may be in horizontal position.

Motors with sealable plastic drain plugs are delivered in an open position. In very dusty environments, all drain holes should be closed.

4.9 Cabling and electrical connections

The terminal box on standard single speed motors normally contains six winding terminals and at least one earth terminal.

In addition to the main winding and earthing terminals, the terminal box can also contain connections for thermistors, heating elements or other auxiliary devices.

Suitable cable lugs must be used for the connection of all main cables. Cables for auxiliaries can be connected into their terminal blocks as such.

Motors are intended for fixed installation only. Unless otherwise specified, cable entry threads are metric. The IP class of the cable gland must be at least the same as those of the terminal boxes.

Certified conduit hub or cable connector has to be used at the time of installation.



Cables should be mechanically protected and clamped close to the terminal box to fulfill the appropriate requirements of IEC/EN 60079-0 and local installation standards.

Unused cable entries must be closed with blanking elements according to the IP class of the terminal box.

The degree of protection and diameter are specified in the documents relating to the cable gland.



WARNING

Use appropriate cable glands and seals in the cable entries according to the type and diameter of the cable.

Earthing must be carried out according to local regulations before the motor is connected to the supply voltage.

The earth terminal on the frame has to be connected to PE (protective earth) with a cable as shown in Table 5 of IEC/EN 60034-1:

Table 4.1: Minimum cross-sectional area of protective conductors

Cross-sectional area of phase conductors of the installation, S, [mm ²]	Minimum cross-sectional area of the corresponding protective conductor, S, [mm ²]
4	4
6	6
10	10
16	16
25	25
35	25
50	25
70	35
95	50
120	70
150	70
185	95
240	120
300	150
400	185

In addition, earthing or bonding connection facilities on the outside of electrical apparatus must provide effective connection of a conductor with a cross-sectional area of at least 4 mm².

The cable connection between the network and motor terminals must meet the requirements stated in the national standards for installation or in the standard IEC/EN 60204-1 according to the rated current indicated on the rating plate.

i

When the ambient temperature exceeds +50 °C, cables having permissible operating temperature of +90 °C as minimum shall be used. Also all other conversion factors depending on the installation conditions shall be taken into account while sizing the cables.

Ensure that the motor protection corresponds to the environment and weather conditions. For example, make sure that water cannot enter the motor or the terminal boxes.

The seals of terminal boxes must be placed correctly in the slots provided to ensure the correct IP class. A leak could lead to penetration of dust or water, creating a risk of flashover to live elements.

4.9.1 Connections for different starting methods

The terminal box on standard single speed motors normally contains six winding terminals and at least one earth terminal. This enables the use of DOL- or Y/D –starting.

For two-speed and special motors, the supply connection must follow the instructions inside the terminal box or in the motor manual.

The voltage and connection are stamped on the rating plate.

Direct-on-line starting (DOL):

Y or D winding connections may be used.

For example, 690 VY, 400 VD indicates Y-connection for 690 V and D-connection for 400 V.

Star/Delta (Wye/Delta) starting (Y/D):

The supply voltage must be equal to the rated voltage of the motor when using a D-connection.

Remove all connection links from the terminal block.

Other starting methods and severe starting conditions:

In cases where other starting methods e.g. converter or soft starter will be used in the duty types of S1 and S2, it is considered that the device is “isolated from the power system when the electrical machine is running” as in the standard IEC 60079-0 and thermal protection is optional.

4.9.2 Connections of auxiliaries

If a motor is equipped with thermistors or other RTDs (Pt100, thermal relays, etc.) and auxiliary devices, it is recommended they be used and connected by appropriate means. For certain applications, it is mandatory to use thermal protection. More detailed information can be found in the documents delivered with the motor. Connection diagrams for auxiliary elements and connection parts can be found inside the terminal box.

The maximum measuring voltage for the thermistors is 2.5 V. The maximum measuring current for Pt100 is 5 mA. Using a higher measuring voltage or current may cause errors in readings or a damaged temperature detector.

The insulation of thermal sensors fulfills the requirements of basic insulation.

4.10 Terminals and direction of rotation

The shaft rotates clockwise when viewing the shaft face at the motor drive end, and the line phase sequence – L1, L2, L3 – is connected to the terminals as shown in figure 3.

To alter the direction of rotation, interchange any two connections on the supply cables.

If the motor has a unidirectional fan, ensure that it rotates in the same direction as the arrow marked on the motor.

5 Operation

5.1 General

The motors are designed for the following conditions unless otherwise stated on the rating plate:

- Motors are to be installed in fixed installations only.
- Normal ambient temperature range is from $-20\text{ }^{\circ}\text{C}$ to $+40\text{ }^{\circ}\text{C}$.
- Maximum altitude is 1000 m above sea level.
- The variation of the supply voltage and frequency may not exceed the limits mentioned in relevant standards. Tolerance for supply voltage is $\pm 5\%$, and for frequency $\pm 2\%$ according to the figure 4 (EN / IEC 60034-1, paragraph 7.3, Zone A). Both extreme values are not supposed to occur at the same time.

The motor can only be used in applications for which it is intended. The rated nominal values and operation conditions are shown on the motor rating plates. In addition, all requirements of this manual and other related instructions and standards must be followed.

If these limits are exceeded, motor data and construction data must be checked. Please contact Bonfiglioli for further information.



WARNING

Ignoring any instructions or maintenance of the apparatus may jeopardize safety and thus prevent the use of the motor.

6 Low voltage motors in variable speed operation

6.1 Introduction

This part of the manual provides additional instructions for motors used in frequency converter supplies. The motor is intended to operate from a single frequency converter supply and not motors running in parallel from one frequency converter. Instructions given by the converter manufacturer shall be followed.

Additional information may be required by Bonfiglioli to decide on the suitability for some motor types used in special applications or with special design modifications.

6.2 Winding insulation

Variable speed drives create higher voltage stresses than the sinusoidal supply on the winding of the motor. Therefore, the winding insulation of the motor as well as the filter at the converter output must be dimensioned according following instructions.

6.2.1 Selection of winding insulation with converters

The voltage stresses must be limited below accepted limits. Please contact the system

supplier to ensure the safety of the application. The influence of possible filters must be taken into account while dimensioning the motor.

6.3 Thermal protection

Most of the motors covered by this manual are equipped with PTC thermistors or other type of RTD's in the stator windings. It is recommended to connect those to the frequency converter. Read more in chapter 4.9.2.

6.4 Bearing currents

Insulated bearings or bearing constructions, common mode filters and suitable cabling and grounding methods must be used.

i

Insulated bearings which have aluminum oxide coated inner and/or outer bores or ceramic rolling elements are recommended. Aluminum oxide coatings shall also be treated with a sealant to prevent dirt and humidity penetrating into the porous coating. For the exact type of bearing insulation, see the motor's rating plate. Changing the bearing type or insulation method without Bonfiglioli's permission is prohibited.

6.4.1 Elimination of bearing currents with converters

The user is responsible for protecting the motor and driven equipment from harmful bearing currents.

6.5 Cabling, grounding and EMC

To provide proper grounding and to ensure compliance with any applicable EMC requirements, motors above 30 kW shall be cabled by shielded symmetrical cables and EMC glands, i.e. cable glands providing 360° bonding.

Symmetrical and shielded cables are highly recommended also for smaller motors. Make the 360° grounding arrangement at all the cable entries as described in the instructions for the glands. Twist the cable shields into bundles and connect to the nearest ground terminal/bus bar inside the terminal box, converter cabinet, etc.

i

Proper cable glands providing 360° bonding must be used at all termination points such as motor, converter, possible safety switch, etc.

For motors of frame size IEC 280 and above, additional potential equalization between the motor frame and the driven equipment is needed, unless both are mounted on a common steel base. In this case, the high frequency conductivity of the connection provided by the steel base should be checked by, for example, measuring the potential difference between the components.

More information about grounding and cabling of variable speed drives can be found in the manual "Grounding and cabling of the drive system" (Code: 3AFY 61201998).

6.6 Operating speed

For speeds higher than the nominal speed stated on the motor's rating plate or in the respective product catalog, ensure that either the highest permissible rotational speed of the motor or the critical speed of the whole application is not exceeded.

6.7 Motors in variable speed applications

6.7.1 General

With frequency converters the motors must be dimensioned manually. For more information, please contact Bonfiglioli.

The loadability curves (or load capacity curves) are based on nominal supply voltage. Operation in under or over voltage conditions may influence on the performance of the application.

6.7.2 Motor loadability with other voltage source PWM-type converters

For other converters, with uncontrolled DC voltage and minimum switching frequency of 3 kHz (200...500 V). Please contact the manufacturer of the converter or the system supplier.



The actual thermal loadability of a motor may be lower than shown by guideline curves.

6.7.3 Short time overloads

Bonfiglioli motors can usually be temporarily overloaded as well as used in intermittent duties.

6.8 Rating plates

The usage of Bonfiglioli's motors in variable speed applications do not usually require additional rating plates. The parameters required for commissioning the converter can be found from the main rating plate. In some special applications, however, the motors can be equipped with additional rating plates for variable speed applications.

Those include the following information:

- speed range
- power range
- voltage and current range
- type of torque (constant or quadratic)
- and converter type and required minimum switching frequency.

6.9 Commissioning the variable speed application

The commissioning of the variable speed application must be done according to the instructions of the frequency converter and local laws and regulations. The requirements and limitations set by the application must also be taken into account.

All parameters needed for setting the converter must be taken from the motor rating plates.

The most often needed parameters are:

- nominal voltage
- nominal current
- nominal frequency
- nominal speed
- nominal power



In case of missing or inaccurate information, do not operate the motor before ensuring correct settings!

Bonfiglioli recommends using all the suitable protective features provided by the converter to improve the safety of the application. Converters usually provide features such as (names and availability of features depend on manufacturer and model of the converter):

- minimum speed
- maximum speed
- acceleration and deceleration times
- maximum current

7 Maintenance



WARNING

Voltage may be connected at standstill inside the terminal box for heating elements or direct winding heating.

7.1 General inspection

1. Inspect the motor at regular intervals, at least once a year. The frequency of checks depends on, for example, the humidity level of the ambient air and on the local weather conditions. This can initially be determined experimentally and must then be strictly adhered to.
2. Keep the motor clean and ensure free ventilation airflow. If the motor is used in a dusty environment, the ventilation system must be regularly checked and cleaned.
3. Check the condition of shaft seals (e.g. V-ring or radial seal) and replace if necessary.
4. Check the condition of connections and mounting and assembly bolts.
5. Check the bearing condition by listening for any unusual noise, vibration measurement, bearing temperature, inspection of spent grease or SPM bearing monitoring. Pay special attention to bearings when their calculated rated life time is coming to an end.

When signs of wear are noticed, dismantle the motor, check the parts and replace if necessary. When bearings are changed, replacement bearings must be of the same type as those originally fitted. The shaft seals have to be replaced with seals of the same quality and characteristics as the originals when changing bearings.

In the case of the IP 55 motor and when the motor has been delivered with a plug closed, it is advisable to periodically open the drain plugs in order to ensure that the way out for condensation is not blocked and allows condensation to escape from the motor. This operation must be done when the motor is at a standstill and has been made safe to work on.

7.1.1 Standby motors

If the motor is in standby for a longer period of time on a ship or in other vibrating environment the following measures have to be taken:

1. The shaft must be rotated regularly every 2 weeks (to be reported) by means of starting up of the system. In case a start-up is not possible, for any reason, at least the shaft has to be turned by hand in order to achieve a different position once a week. Vibrations caused by other vessel's equipment will cause bearing pitting which should be minimized by regular operation/hand turning.
2. The bearing must be greased while rotating the shaft every year (to be reported). If the motor has been provided with roller bearing at the driven end, the transport lock must be removed before rotating the shaft. The transport locking must be remounted in case of transportation.
3. All vibrations must be avoided to prevent a bearing from failing. All instructions in the motor instruction manual for commissioning and maintenance have to be followed. The warranty will not cover the winding and bearing damages if these instructions have not been followed.

7.2 Lubrication



WARNING

Beware of all rotating parts!



WARNING

Grease can cause skin irritation and eye inflammation. Follow all safety precautions specified by the manufacturer of the grease.

Bearing types are specified in the respective product catalogs and on the rating plate of all motors, except smaller frame sizes.

Reliability is a vital issue for bearing lubrication intervals. Bonfiglioli uses mainly the L1 -principle (i.e. that 99 % of the motors are certain to make the life time) for lubrication.

7.2.1 Motors with permanently greased bearings

Bearings are usually permanently greased bearings of 1Z, 2Z, 2RS or equivalent.

As a guide, adequate lubrication for sizes up to 250 can be achieved for the following duration, according to L_1 . For duties with higher ambient temperatures, please contact Bonfiglioli. The informative formula to change the L1 values roughly to

L_{10} values: $L_{10} = 2.0 \times L_1$.

Duty hours for permanently greased bearings at ambient temperatures of 25 °C and 40 °C are:

Table 7.1

Frame size	Poles	Duty hours at 25 °C	Duty hours at 40 °C
200	2	41 000	25 000
200	4-8	95 000	60 000
225	2	36 000	23 000
225	4-8	88 000	56 000
250	2	31 000	20 000
250	4-8	80 000	50 000

Data is valid up to 60 Hz.

7.2.2 Motors with regreasable bearings

Lubrication information plate and general lubrication advice.

If the motor is equipped with a lubrication information plate, follow the given values.

Greasing intervals regarding mounting, ambient temperature and rotational speed are defined on the lubrication information plate.

During the first start or after a bearing lubrication a temporary temperature rise may appear, approximately 10 to 20 hours.

Some motors may be equipped with a collector

for old grease. Follow the special instructions given for the equipment.

A. Manual lubrication

Regreasing while the motor is running

- Remove grease outlet plug or open closing valve if fitted.
- Be sure that the lubrication channel is open.
- Inject the specified amount of grease into the bearing.
- Let the motor run for 1-2 hours to ensure that all excess grease is forced out of the bearing. Close the grease outlet plug or closing valve, if fitted.

Regreasing while the motor is at a standstill

If it is not possible to re-grease the bearings while the motors are running, lubrication can be carried out while the motor is at a standstill.

- In this case, use only half the amount of grease and then run the motor for a few minutes at full speed.
- When the motor has stopped, apply the rest of the specified amount of grease to the bearing.
- After 1–2 running hours, close the grease outlet plug or closing valve, if fitted.

B. Automatic lubrication

The grease outlet plug must be removed permanently with automatic lubrication or open closing valve, if fitted.

Bonfiglioli recommends only the use of electro-mechanical systems.

The amount of grease per lubrication interval stated in the table should be multiplied by three if a central lubrication system is used. When using a smaller automatic re-grease unit (one or two cartridges per motor) the normal amount of grease can be used.

When 2-pole motors are automatically re-greased, the note concerning lubricant recommendations for 2-pole motors in the Lubricants chapter should be followed.

The used grease should be suitable for automatic lubrication. The automatic lubrication system deliverer and the grease manufacturer's recommendations should check.

Calculation example of amount of grease for automatic lubrication system

Central lubrication system: Motor IEC M3_P 315_4-pole in 50 Hz network, re-lubrication interval according to Table is 7600 h/55 g (DE) and

7600 h/40 g (NDE):

(DE) RLI = $55 \text{ g}/7600 \text{ h} \cdot 3 \cdot 24 = 0,52 \text{ g/day}$

(NDE) RLI = $40 \text{ g}/7600 \text{ h} \cdot 3 \cdot 24 = 0,38 \text{ g/day}$

Calculation example of amount of grease for single automation lubrication unit (cartridge)

(DE) RLI = $55 \text{ g}/7600 \text{ h} \cdot 24 = 0,17 \text{ g/day}$

(NDE) RLI = $40 \text{ g}/7600 \text{ h} \cdot 24 = 0,13 \text{ g/day}$

RLI = Re-lubrication interval, DE = Drive end,
NDE = Non drive end

7.2.3 Lubrication intervals and amounts

Lubrication intervals for vertical motors are half of the values shown in the table below.

As a guide, adequate lubrication can be achieved for the following duration, according to L_1 . For duties with higher ambient temperatures please contact Bonfiglioli. The informative formula to change the L1 values roughly to L10 values is $L_{10} = 2.0 \times L_1$, with manual lubrication.

The lubrication intervals are based on a bearing operating temperature of 80 °C (ambient temperature +25 °C).

i

An increase in the ambient temperature raises the temperature of the bearings correspondingly. The interval values should be halved for a 15 °C increase in bearing temperature and may be doubled for a 15 °C decrease in bearing temperature.

Higher speed operation, e.g. in frequency converter applications, or lower speed with heavy load will require shorter lubrication intervals.



WARNING

The maximum operating temperature of the grease and bearings, +110 °C, must not be exceeded. The designed maximum speed of the motor must not be exceeded.

Table 7.2

Frame size	Amount of grease g/bearing	kW	3600 r/min	3000 r/min	kW	1800 r/min	1500 r/min	kW	1000 r/min	kW	500-900 r/min
Ball bearings, lubrication intervals in duty hours											
200	40	≤ 37	5 500	8 000	≤ 30	14 500	17 500	≤ 22	23 000	all	24 000
200	40	> 37	3 000	5 500	> 30	10 000	12 000	> 22	16 000	all	20 000
225	50	≤ 45	4 000	6 500	≤ 45	13 000	16 500	≤ 30	22 000	all	24 000
225	50	> 45	1 500	2 500	> 45	5 000	6 000	> 30	8 000	all	10 000
250	60	≤ 55	2 500	4 000	≤ 55	9 000	11 500	≤ 37	15 000	all	18 000
250	60	> 55	1 000	1 500	> 55	3 500	4 500	> 37	6 000	all	7 000
280 ¹⁾	60	all	2 000	3 500	–	–	–	–	–	–	–
280 ¹⁾	60	–	–	–	all	8 000	10 500	all	14 000	all	17 000
280	35	all	1 900	3 200	–	–	–	–	–	–	–
280	40	–	–	–	all	7 800	9 600	all	13 900	all	15 000
315	35	all	1 900	3 200	–	–	–	–	–	–	–
315	55	–	–	–	all	5 900	7 600	all	11 800	all	12 900
355	35	all	1 900	3 200	–	–	–	–	–	–	–
355	70	–	–	–	all	4 000	5 600	all	9 600	all	10 700
400	40	all	1 500	2 700	–	–	–	–	–	–	–
400	85	–	–	–	all	3 200	4 700	all	8 600	all	9 700
450	40	all	1 500	2 700	–	–	–	–	–	–	–
450	95	–	–	–	all	2 500	3 900	all	7 700	all	8 700

Frame size	Amount of grease g/bearing	kW	3600 r/min	3000 r/min	kW	1800 r/min	1500 r/min	kW	1000 r/min	kW	500-900 r/min
Roller bearings, lubrication intervals in duty hours											
200	40	≤ 37	2 750	4 000	≤ 30	7 000	8 500	≤ 22	11 500	all	12 000
200	40	> 37	1 500	2 500	> 30	5 000	6 000	> 22	8 000	all	10 000
225	50	≤ 45	2 000	3 000	≤ 45	6 500	8 000	≤ 30	11 000	all	12 000
225	50	> 45	750	1 250	> 45	2 500	3 000	> 30	4 000	all	5 000
250	60	≤ 55	1 000	2 000	≤ 55	4 500	5 500	≤ 37	7 500	all	9 000
250	60	> 55	500	750	> 55	1 500	2 000	> 37	3 000	all	3 500
280 ¹⁾	60	all	1 000	1 750	–	–	–	–	–	–	–
280 ¹⁾	70	–	–	–	all	4 000	5 250	all	7 000	all	8 500
280	35	all	900	1 600	–	–	–	–	–	–	–
280	40	–	–	–	all	4 000	5 300	all	7 000	all	8 500
315	35	all	900	1 600	–	–	–	–	–	–	–
315	55	–	–	–	all	2 900	3 800	all	5 900	all	6 500
355	35	all	900	1 600	–	–	–	–	–	–	–
355	70	–	–	–	all	2 000	2 800	all	4 800	all	5 400
400	40	all	–	1 300	–	–	–	–	–	–	–
400	85	–	–	–	all	1 600	2 400	all	4 300	all	4 800
450	40	all	–	1 300	–	–	–	–	–	–	–
450	95	–	–	–	all	1 300	2 000	all	3 800	all	4 400

¹⁾ M3AA

7.2.4 Lubricants



WARNING

Do not mix different types of grease.
Incompatible lubricants may cause bearing damage.

When re-greasing, use only special ball bearing grease with the following properties:

- good quality grease with lithium complex soap and with mineral- or PAO-oil
- base oil viscosity 100-160 cST at 40 °C
- consistency NLGI grade 1.5 - 3 *)
- temperature range –30 °C - +120 °C, continuously

*) A stiffer end of scale is recommended for vertical mounted motors or in hot conditions.

The above mentioned grease specification is valid if the ambient temperature is above –30 °C or below +55 °C, and the bearing temperature is below 110 °C; otherwise, consult Bonfiglioli regarding suitable grease.

Grease with the correct properties is available from all major lubricant manufacturers.

Admixtures are recommended, but a written guarantee must be obtained from the lubricant manufacturer, especially concerning EP admixtures, that admixtures do not damage bearings or the properties of lubricants at the operating temperature range.



WARNING

In general, lubricants containing EP admixtures are not recommended. In some cases it can cause harm in the bearing, therefore its use has to be evaluated case by case together with lubricant suppliers.

The following high performance greases can be used:

- **Mobil Unirex N2 or N3** (lithium complex base)
- **Mobil Mobilith SHC 100** (lithium complex base)
- **Shell Gadus S5 V 100 2** (lithium complex base)
- **Klüber Klüberplex BEM 41-132** (special lithium base)
- **FAG Arcanol TEMP110** (lithium complex base)
- **Lubcon Turmogrease L 802 EP PLUS** (special lithium base)
- **Total Multis Complex S2 A** (lithium complex base)



Always use high speed grease for high speed 2-pole motors where the speed factor is higher than 480,000 (calculated as $D_m \times n$ where D_m = average bearing diameter, mm; n = rotational speed, r/min).

The following greases can be used for high speed cast iron motors but not mixed with lithium complex greases:

- **Klüber Klüber Quiet BQH 72-102** (polyurea base)
- **Lubcon Turmogrease PU703** (polyurea base)

If other lubricants are used, check with the manufacturer that the qualities correspond to those of the above mentioned lubricants. The lubrication intervals are based on the listed high performance greases above. Using other greases can reduce the interval.

8 After Sales Support

8.1 Spare parts

Unless otherwise stated, spare parts must be original parts or approved by Bonfiglioli.

When ordering spare parts, the motor serial number, full type designation and product code, as stated on the rating plate, must be specified.

8.2 Dismantling, re-assembly and rewinding

Rewinding should always be carried out by qualified repair shops.

Smoke venting and other special motors should not be rewound without first contacting Bonfiglioli.

8.3 Bearings

Special care should be taken with the bearings.

These must be removed using pullers and fitted by heating or using special tools.

Bearing replacement is described in detail in a separate instruction leaflet available from the Bonfiglioli Sales Office.

Any directions placed on the motor, such as labels, must be followed. The bearing types indicated on the rating plate must not be changed.

9 Environmental requirements

Most of Bonfiglioli's motors have a sound pressure level not exceeding 82 dB (A) (± 3 dB) at 50 Hz.

Values for specific motors can be found in the relevant product catalogs. At 60 Hz sinusoidal supply, the values are approximately 4 dB(A) higher compared to 50 Hz values stated in the product catalogs.

For sound pressure levels at frequency converter supplies, please contact Bonfiglioli.

When motor(s) need to be scrapped or recycled, appropriate means, local regulations and laws must be followed.

9.1 EU Directive 2012/19/EU (WEEE)

EU Directive 2012/19/EU (WEEE) gives end-users the necessary information on how to treat and dispose of EEE (Electrical and Electronic Equipment) waste after it has been removed from service and is to be recycled.

9.1.1 Marking of the products



Products that are marked with the crossed-out wheeled bin symbol as below and/or the symbol is included in its documentation shall be handled in the following way:

9.1.2 For private households

The crossed-out wheeled bin symbol on the product(s) and / or accompanying documents means that used electrical and electronic equipment (WEEE) should not be mixed with general household waste. For proper treatment, recovery and recycling, please take this product(s) to a designated collection point where it will be accepted free of charge.

Alternatively, in some countries, you may be able to return your products to your local retailer upon purchase of an equivalent new product.

Disposing of this product correctly will help save valuable resources and prevent any potential negative effects on human health and the environment, which might otherwise arise from inappropriate waste handling.

Please contact your local authority for further details of your nearest designated collection point. Depending on your national legislation, incorrect disposal of this waste may incur a penalty in your country.

9.1.3 For professional users in the European Union

The crossed-out wheeled bin symbol on the product(s) and / or accompanying documents means that used electrical and electronic equipment (WEEE) should not be mixed with general household waste.

If you wish to dispose of electrical and electronic equipment (EEE), please contact your dealer or supplier for further information.

Disposing of this product correctly will help save valuable resources and prevent any potential negative effects on human health and the environment, which could otherwise arise from inappropriate waste handling.

9.1.4 For disposal in countries outside of the European Union

The crossed-out wheeled bin symbol is only valid in the European Union (EU) and means that used electrical and electronic equipment (WEEE) should not be mixed with general household waste.

If you wish to dispose of this product, please contact your local authorities or dealer for the correct method of disposal.

Disposing of this product correctly will help save valuable resources and prevent any potential negative effects on human health and the environment, which could otherwise arise from inappropriate waste handling.

10 Troubleshooting

These instructions do not cover all details or variations in equipment nor provide information for every possible condition to be met in connection with installation, operation or maintenance. Should additional information be required, please contact the nearest Bonfiglioli Sales Of-

Motor troubleshooting chart

Your motor service and any troubleshooting must be handled by qualified persons who have the proper tools and equipment.

Table 10.1: Troubleshooting

TROUBLE	CAUSE	WHAT TO DO
Motor fails to start	Blown fuses	Replace fuses with proper type and rating.
	Overload trips	Check and reset overload in starter.
	Improper power supply	Check to see that power supplied agrees with motor rating plate and load factor.
	Improper line connections	Check connections against diagram supplied with motor.
	Open circuit in winding or control switch	Indicated by humming sound when switch is closed. Check for loose wiring connections and ensure that all control contacts are closing.
	Mechanical failure	Check to see if motor and drive turn freely. Check bearings and lubrication.
	Short circuited stator	Contact Bonfiglioli or Ensure that the supply is disconnected and grounding for work done, disconnect the cables and measure the insulation resistance.
	Poor stator coil connection	Indicated by blown fuses. Motor must be rewound. Remove end shields and locate fault.
	Motor may be overloaded	Reduce load.
Motor stalls	One phase may be open	Check lines for open phase.
	Wrong application	Change type or size. Consult equipment supplier.
	Overload	Reduce load.
	Low voltage	Ensure the rating plate voltage is maintained. Check connection.
	Open circuit	Fuses blown. Check overload relay, stator and push buttons.
Motor runs and then dies down	Power failure	Check for loose connections to line, fuses and control.
Motor does not accelerate up to nominal speed	Not applied properly	Consult equipment supplier for proper type.
	Voltage too low at motor terminals because of line drop	Use higher voltage or transformer terminals or reduce load. Check connections. Check conductors for proper size.
	Starting load too high	Check the motor's starts against "no load".
	Broken rotor bars or loose rotor	Look for cracks near the rings. A new rotor may be required, as repairs are usually temporary.
	Open primary circuit	Locate fault with testing device and repair.

TROUBLE	CAUSE	WHAT TO DO
Motor takes too long to accelerate and/or draws high current	Excessive load	Reduce load.
	Low voltage during start	Check for high resistance. Make sure that an adequate cable size is used.
	Defective squirrel cage rotor	Replace with new rotor.
	Applied voltage too low	Correct power supply.
Wrong rotation direction	Wrong sequence of phases	Reverse connections at motor or at switchboard.
Motor overheats while running	Overload	Reduce load.
	Frame or ventilation openings may be full of dirt and prevent proper ventilation of motor	Open vent holes and check for a continuous stream of air from the motor.
	Motor may have one phase open	Check to make sure that all leads and cables are well connected.
	Grounded coil	Motor must be rewound.
	Unbalanced terminal voltage	Check for faulty leads, connections and transformers.
Motor vibrates	Motor misaligned	Realign.
	Weak support	Strengthen base.
	Coupling out of balance	Balance coupling.
	Driven equipment unbalanced	Rebalance driven equipment.
	Defective bearings	Replace bearings.
	Bearings not in line	Repair motor
	Balancing weights shifted	Rebalance rotor.
	Contradiction between balancing of rotor and coupling (half key - full key)	Rebalance coupling or rotor.
	Poly phase motor running single phase	Check for open circuit.
	Excessive end play	Adjust bearing or add shim.
Scraping noise	Fan rubbing end shield or fan cover	Correct fan mounting.
	Loose on bedplate	Tighten holding bolts.
Noisy operation	Air gap not uniform	Check and correct end shield fits or bearing fits.
	Rotor unbalance	Rebalance rotor.
Hot bearings	Bent or sprung shaft	Straighten or replace shaft.
	Excessive belt pull	Decrease belt tension.
	Pulleys too far away from shaft shoulder	Move pulley closer to motor bearing.
	Pulley diameter too small	Use larger pulleys.
	Misalignment	Correct by realignment of the drive.
	Insufficient grease	Maintain proper quality and amount of grease in bearing.
	Deterioration of grease or lubricant contaminated	Remove old grease, wash bearings thoroughly in kerosene and replace with new grease.
	Excess lubricant	Reduce quantity of grease, bearing should not be more than half full.
	Overloaded bearing	Check alignment, side and end thrust.
	Broken ball or rough races	Replace bearing, clean housing thoroughly first.

11 Figures

—
Figure 1. Diagram illustrating the insulation resistance dependence from the temperature and how to correct the measured insulation resistance to the temperature of 40 °C.

—
Figure 2. Mounting of half-coupling or pulley

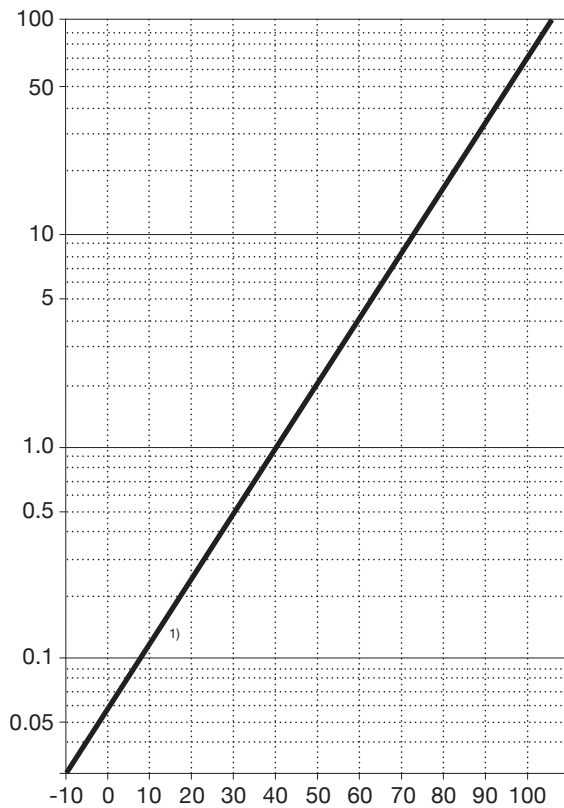

Figure 1.

X-axis: Winding temperature, Celsius Degrees

Y-axis: Insulation Resistance

Key Temperature Coefficient, k_{tc}

1) To correct observed insulation resistance, R_i, to 40 °C multiply it by the temperature coefficient k_{tc} · R_{i40°C} = R_i x

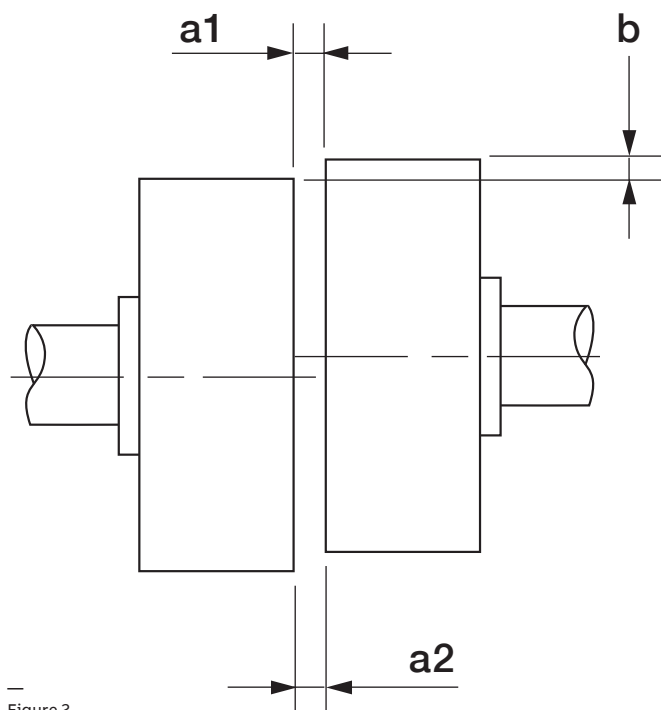

Figure 2.

Figure 3. Connection of terminals for main supply

Figure 4. Voltage and frequency deviation in zones A and B

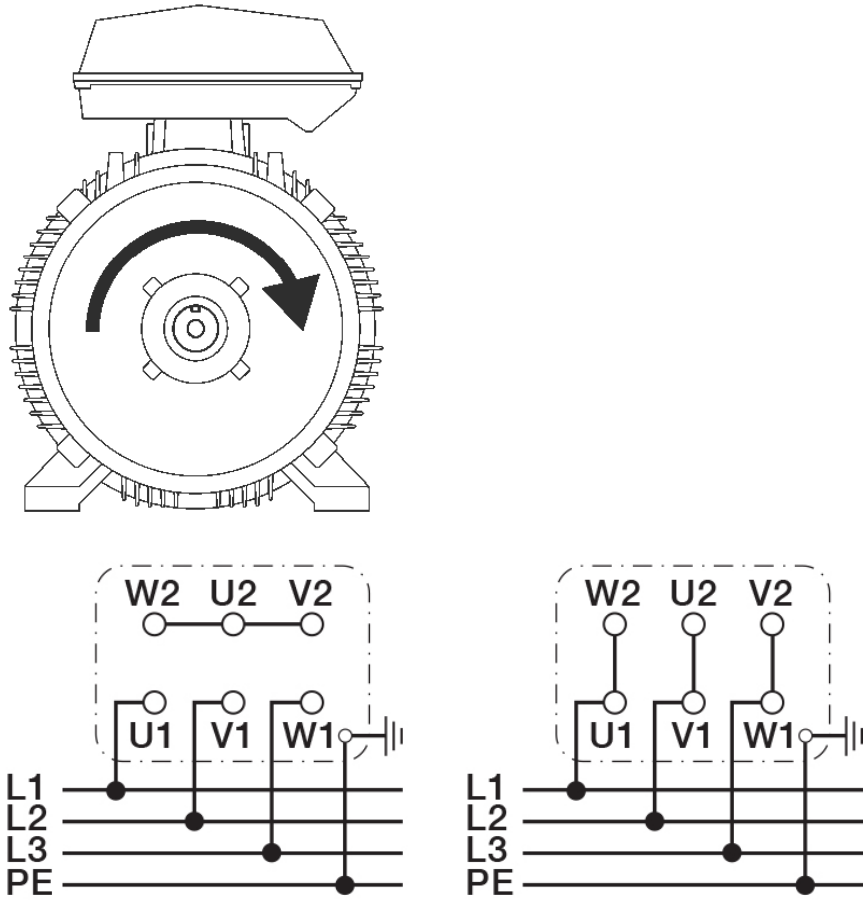

Figure 3.

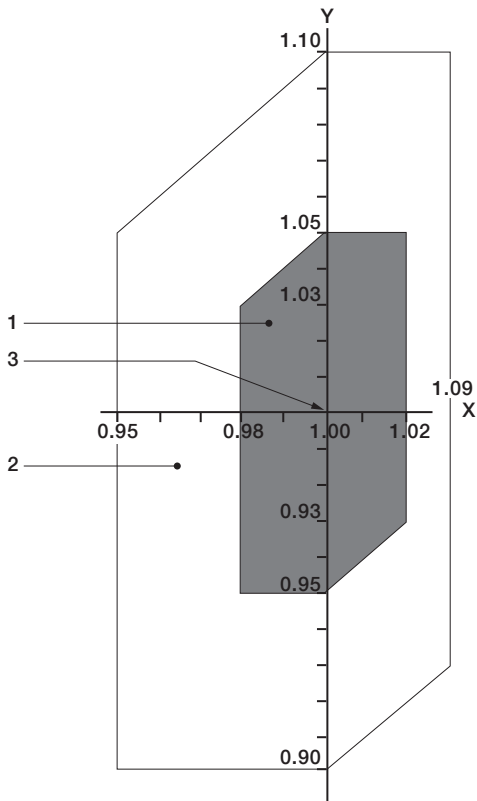

Figure 4.

	X axis	frequency p.u.
	Y axis	voltage p.u.
Key	1	zone A
	2	zone B (outside zone A)
	3	rating point



Guideline loadability curves with converters with DTC control

Figure 5a. Converter with DTC control, 50 Hz, temperature rise B

Figure 5b. Converter with DTC control, 60 Hz, temperature rise B

Figure 5c. Converter with DTC control, 50 Hz, temperature rise F

Figure 5d. Converter with DTC control, 60 Hz, temperature rise F

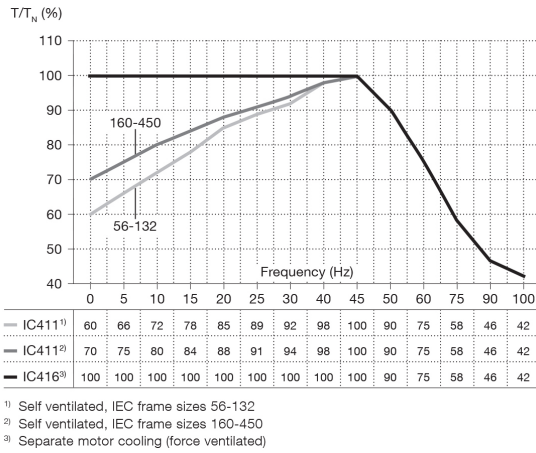

Figure 5a.

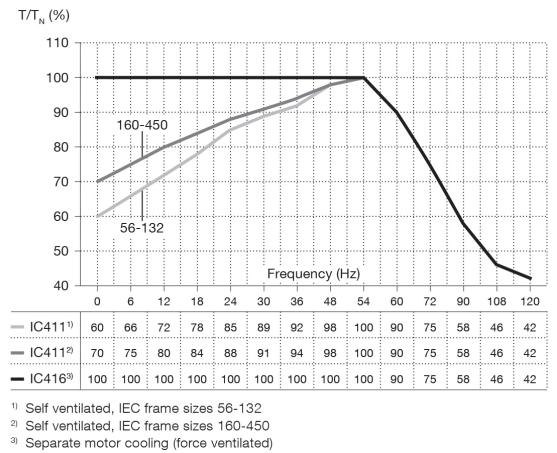

Figure 5b.

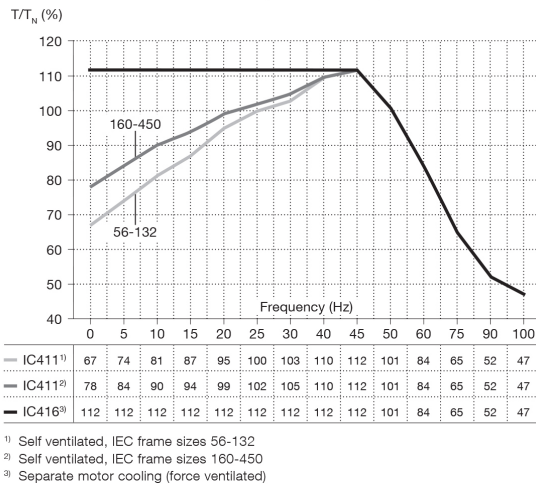

Figure 5c.

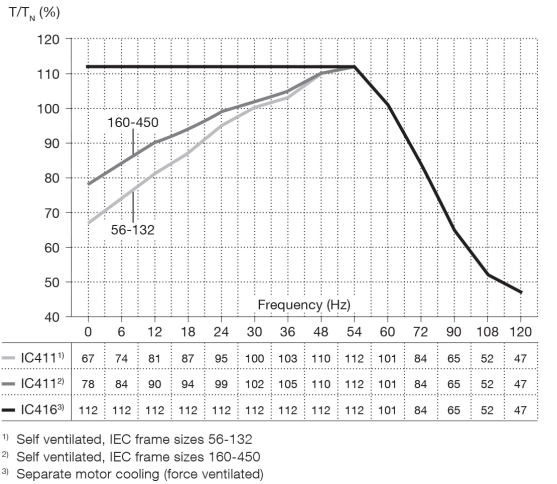

Figure 5d.



Guideline loadability curves with other voltage source PWM type

Figure 6a. Other voltage source PWM type converter, 50 Hz, temperature rise B

Figure 6b. Other voltage source PWM type converter, 60 Hz, temperature rise B

Figure 6c. Other voltage source PWM type converter, 50 Hz, temperature rise F

Figure 6d. Other voltage source PWM type converter, 60 Hz, temperature rise F

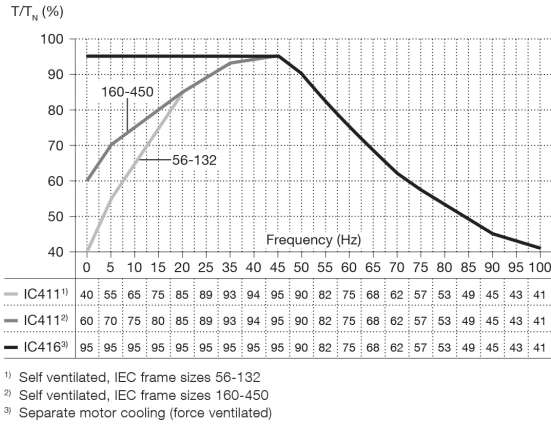

Figure 6a.

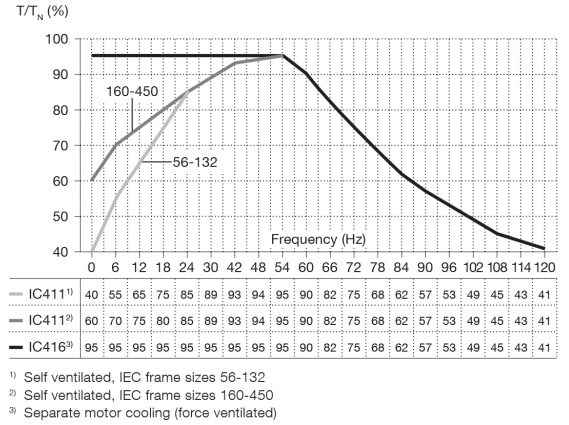

Figure 6b.

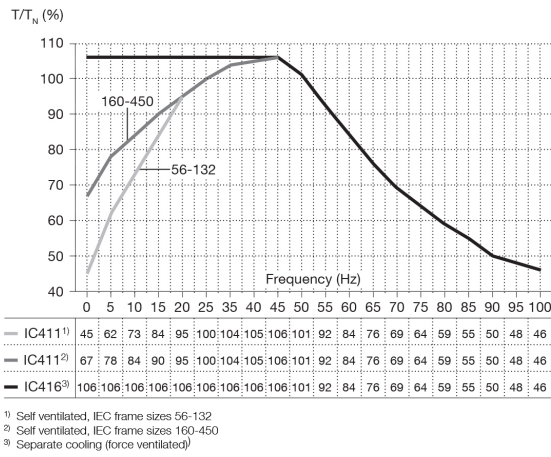

Figure 6c.

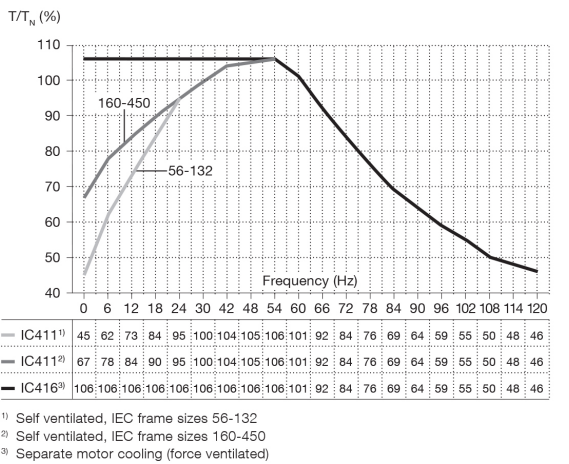

Figure 6d.





We have a relentless commitment to excellence, innovation & sustainability. Our team creates, distributes and services world-class power transmission & drive solutions to keep the world in motion.



HEADQUARTERS

Bonfiglioli Riduttori S.p.A.

Via Giovanni XXIII, 7/A

40012 Lippo di Calderara di Reno

Bologna (Italy)

tel: +39 051 647 3111

fax: +39 051 647 3126

bonfiglioli@bonfiglioli.com

www.bonfiglioli.com